Installation, Operation and Service Manual



Welcome to Follett Products LLC

Follett Products equipment enjoys a well-deserved reputation for excellent performance, long-term reliability and outstanding after-the-sale support. To ensure that this equipment delivers that same degree of service, review this guide carefully before you begin your installation.

Should you need technical help, please call our Technical Service group at (877) 612-5086 or (610) 252-7301.

Please have your model number, serial number and complete and detailed explanation of the problem when contacting Technical Service.

Getting Started

After uncrating and removing all packing material, inspect the equipment for concealed shipping damage. All freight is to be inspected upon delivery. If visible signs of damage exist, please refuse delivery or sign your delivery receipt “damaged.” Follett Customer Service must be notified within 48 hours. Wherever possible, please include detailed photos of the damage with the original packaging so that we may start the freight claim process.

Preliminary Information

Caution Symbols



Warning: Flammable Refrigerant



Caution: Risk of danger to operator or harm to equipment. Refer to manual.

DANGER

- Risk of fire or explosion. Flammable refrigerant used.

Before attempting to install or service this product, all safety precautions must be followed.

CAUTION! – Risk of fire or explosion. Dispose of properly in accordance with federal or local regulations. Flammable refrigerant used.

CAUTION! – Risk of fire or explosion due to puncture of refrigerant tubing; follow handling instructions carefully. Flammable refrigerant used.

CAUTION! – Handling, moving, and operating the refrigerator to avoid either damaging the refrigerant tubing or increasing the risk of a leak.

CAUTION!

- If the equipment is not transported vertically, a period of at least 24 hours must be allowed before starting.

The equipment must be transported and handled exclusively in upright position. This is required to avoid contamination of the refrigerant with compressor oil. Contamination could result in valve and heat exchanger coil failure, problems starting the electric motor, or the risk of gas leak. The manufacturer is not responsible for any problems due to transport executed in conditions other than those specified.

The equipment must be handled using a fork lift truck or a pallet truck with suitable forks (fork length at least equal to 2/3 length of unit).

WARNING!

- Read this manual thoroughly before operating, installing or performing maintenance on the equipment. Failure to follow instructions in this manual can cause property damage, injury or death.
- The machine contains R600a refrigerant. R600a (isobutane) is flammable.
- When servicing the equipment, be sure to lock the circuit breaker, and display an in-service notice.
- This equipment contains high-voltage electricity and refrigerant charge. Installation and repairs are to be performed by properly trained technicians aware of the dangers of dealing with high voltage electricity and refrigerant under pressure. The technician must also be certified in proper refrigerant handling and servicing procedures. All lockout and tag out procedures must be followed when working on this equipment.
- Repair on R600a systems must always be done in a well-ventilated area.
- Because R600a is highly flammable, a combustible gas leak detector is required when servicing R600a systems.
- Keep ventilation openings, in the appliance enclosure or in the built-in structure, clear of obstruction.
- Do not use mechanical devices or other means to accelerate the defrosting process, other than those recommended by the manufacturer.
- Do not damage the refrigerant circuit.
- Do not store explosive substances such as aerosol cans with a flammable propellant in this appliance.
- Do not use electrical appliances inside the food storage compartments of the appliance, unless they are of the type recommended by the manufacturer.
- Only use parts recommended or provided by the manufacturer.
- Do not tilt unit further than 30° off vertical during uncrating or installation.
- If the supply cord is damaged, it must be replaced by the manufacturer, its service agent or similarly qualified persons in order to avoid a hazard.
- This appliance is designed for commercial use.
- To reduce risk of shock, disconnect power before servicing.

General Information

- To avoid a rise in temperature in the cabinet and/or contents, only open the door for brief periods of time.
- In the refrigerator compartment, put stored items on the shelves and do not let them contact the wall.

Check your paperwork to determine which configuration you have. Follett configuration numbers are designed to provide information about the type of refrigerator you are receiving.

Specifications						
	REF20i-4S	REF25i-4S	REF20i-6B	REF25i-6B	REF20i-6D/BB	REF25i-6D/BB
Capacity	19.7 ft ³ (558 L)	24.6 ft ³ (697 L)	19.7 ft ³ (558 L)	24.6 ft ³ (697 L)	19.7 ft ³ (558 L)	24.6 ft ³ (697 L)
Usable Space	12.7 ft ³ (0.36 m ³)	16.8 ft ³ (0.48 m ³)	12.8 ft ³ (0.36 m ³)	16.4 ft ³ (0.46 m ³)	13.8 ft ³ (0.39 m ³)	18.2 ft ³ (0.52 m ³)
Storage system	(4) epoxy-coated shelves	(4) epoxy-coated shelves	(6) epoxy-coated baskets	(6) epoxy-coated baskets	(6) stainless drawers	(6) stainless drawers
Exterior width	29.75" (76 cm)	29.75" (76 cm)	29.75" (76 cm)	29.75" (76 cm)	29.75" (76 cm)	29.75" (76 cm)
Exterior depth	29" (74 cm)	35" (89 cm)	29" (74 cm)	35" (89 cm)	29" (74 cm)	35" (89 cm)
Exterior depth with handles	30.5" (78 cm)	36.5" (93 cm)	30.5" (78 cm)	36.5" (93 cm)	30.5" (78 cm)	36.5" (93 cm)
Exterior height with casters	79.5" (202 cm)	79.5" (202 cm)	79.5" (202 cm)	79.5" (202 cm)	79.5" (202 cm)	79.5" (202 cm)
Interior dimensions (w x d x h)	24" x 22.5" x 56" (61 cm x 58 cm x 143 cm)	24" x 28.5" x 56" (61 cm x 73 cm x 143 cm)	24" x 22.5" x 56" (61 cm x 58 cm x 143 cm)	24" x 28.5" x 56" (61 cm x 73 cm x 143 cm)	24" x 22.5" x 56" (61 cm x 58 cm x 143 cm)	24" x 28.5" x 56" (61 cm x 73 cm x 143 cm)
Approx. ship weight	431 lb (196 kg)	477 lb (217 kg)	489 lb (222 kg)	467 lb (212 kg)	519 lb (236 kg)	541 lb (246 kg)
Net weight	361 lb (164 kg)	407 lb (185 kg)	419 lb (190 kg)	396 lb (180 kg)	448 lb (203 kg)	470 lb (213 kg)
BTU/hr normal heat rejection (75 F ambient)	600 BTU/hr (176 Watts)	600 BTU/hr (176 Watts)	600 BTU/hr (176 Watts)	600 BTU/hr (176 Watts)	600 BTU/hr (176 Watts)	600 BTU/hr (176 Watts)
BTU/hr maximum (total) heat rejection, at maximum compressor speed (75 F ambient)	1335 BTU/hr (391 Watts)	1350 BTU/hr (395 Watts)	1335 BTU/hr (391 Watts)	1350 BTU/hr (395 Watts)	1335 BTU/hr (391 Watts)	1350 BTU/hr (395 Watts)

Standard features – all models	
Door	Dual pane, low-E glass, condensation free to 80 F (27 C) air/60% RH
Door handle	ADA-compliant, full length handle with integral lock
Interior/exterior material	Heavy-duty, corrosion resistant stainless steel
Casters	(4) dual-wheel swiveling casters with toe locks
Insulation	2.75" (7 cm) thick, CFC-free foam insulation throughout
Lighting	(2) full length side LED lights
Air circulation system	Ducted air through 12 back plenum openings with front face return
Temperature probe	Stainless steel RTD (resistance temperature detectors) top, bottom probe standard on -BB models, immersible with panel quick-disconnect

Refrigeration System

The REF20i/25i series refrigeration system is designed to give many years of trouble-free service. Except for routine cleaning of the air-cooled condenser and related parts, the refrigeration system requires no service or maintenance. The system uses a capillary tube metering device and is critically charged. Access fittings are not provided. Temporary piercing valves are required to work on the refrigeration system. Follett recommends that if hoses are ever connected to the refrigeration system for service, the refrigerant should be recovered, permanent access valves should be installed and the system evacuated, and recharged by weighing in the correct refrigerant charge (refrigerant R600a, 2.3 oz (65 g)).

Note: Do not charge the system by pressures.

Ambients

Intended for indoor use where:

- Ambient temperature (measured at the condenser inlet) does not exceed 80 F (27 C)
- Ambient relative humidity does not exceed 60% RH (A heated door is recommended for higher humidity environments)
- Altitude is below 2000 m
- Environment is classified as Pollution Degree 2

Clearances

The top of the refrigerator must have 10 inches (25.4 cm) of clear space above the refrigerator to ensure proper ventilation of the refrigeration system.

The back of the refrigerator should have 1 inch (2.5 cm) of clearance to allow for power cord clearance on unit and an additional 1 inch (2.5 cm) if the unit is to be plugged in directly behind the refrigerator.

Ensure placement of refrigerator does not prevent access to main power cord plug for disconnection.

Electrical specifications

- 115 V \pm 10%, 60 Hz, 1 phase
- Running load amps: 0.61A without heated door; max 1.9A with door heater energized 100%
- Full load amps (90% maximum continuous current per UL/CSA/IEC 61010-1 at 40 C): 2.5A
- Minimum circuit ampacity: 15A dedicated circuit
- **Maximum size of branch circuit overcurrent device: 15A dedicated circuit**
- Follett recommends circuit be protected by GFCI breaker
- Product main power cord must be plugged into an outlet that is properly connected to protective earth ground
- Overvoltage Category II

Refrigeration specifications

- Refrigerant R600a, 2.3 oz (65 g)
- Compressor amperage: RLA - 2.10 A, LRA - 2.10 A
- Compressor winding resistances: C-S (16.07 Ω +/- 8%), C-R (16.07 Ω +/- 8%)
- Evaporator fan motor amperage: FLA - 0.2 A
- Condenser fan motor amperage: FLA - 0.4 A
- Condenser inlet air temperature: 75 F (23.9 C)
- Discharge pressure (psi): 88
- Suction pressure (psi): 39

Detail drawing

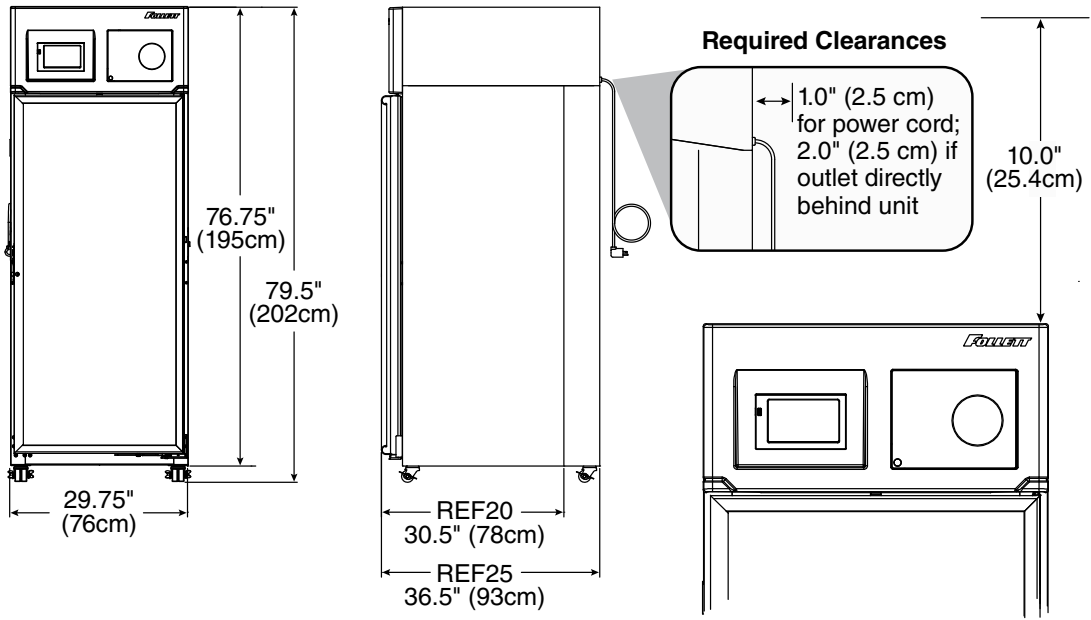

Installation

DANGER



- **Do not tilt any unit further than 30° off vertical during uncrating or installation**
- **Refrigeration module area contains mechanical, moving parts. Keep hands and arms clear of this area at all times. If access to this area is required, power to unit must be disconnected first.**

1. Remove key taped to side of refrigerator cabinet and unlock door.
2. Remove casters from box packed inside refrigerator.
Note: California facilities requiring wall and floor anchors – refer to wall anchor kit instructions (#00938241) packed with seismic kit before proceeding with caster installation.
3. Unbolt refrigerator from pallet.
4. Rotate refrigerator on pallet to install casters (**Fig. 1.1**).
5. Install casters by hand one at a time using channel locks to tighten, until caster meets against the bottom of cabinet (**Fig. 1.2**).
6. Peel protective film from exterior walls of stainless cabinet.

Fig. 1

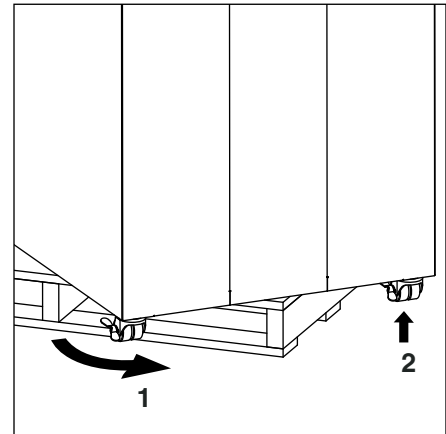

Adjust self-closing door

1. Roll refrigerator to desired location and lock as many casters as possible (**Fig 2.1**).
2. If the door appears to be sagging, remove the philips screw (**Fig. 2.2**) holding the Hold Open Bracket to the Hinge Bracket to gain access to the Sag Adjustment Screw (**Fig. 2.3**). Turn the Sag Adjustment Screw to align the door squarely with the cabinet. When finished, reinstall the Hold Open Bracket.
3. Check door for closing tension and adjust if necessary. To check closing tension, open door 1" and turn screw (**Fig. 2.4**) counterclockwise until you achieve positive close. (Light will go out) Then, turn another half turn counterclockwise.

Fig. 2

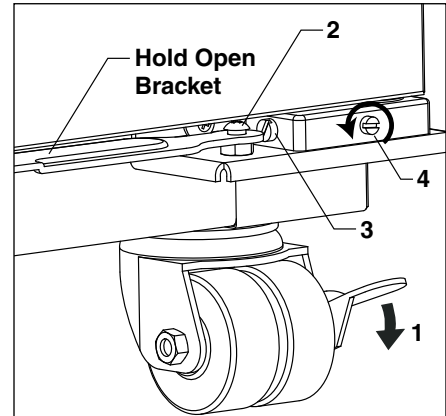

Install shelves (if equipped) and power up

1. If refrigerator is equipped with shelves, remove packaging and then position shelves in desired locations by inserting brackets into pilasters as shown (Fig. 3).
2. Plug refrigerator into a 115 V 60 Hz 15A dedicated outlet.

Attention Installer: In order to maintain compliance to ANSI/NSF 456, do not store product on the bottom floor or against the back or side walls. Product must be stored on a factory supplied shelf, basket or drawer.

Fig. 3

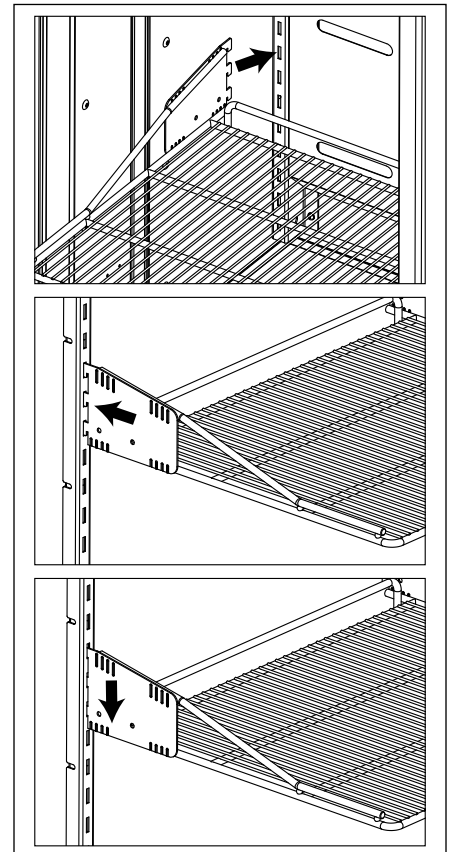

Fill product bottle

ATTENTION INSTALLER

- It is imperative that the top/bottom probe bottle be filled with a solution that your facility uses to ensure proper operation of unit.
- Units are equipped with a third-party monitor installation port. Customers are required to refer to CDC Vaccine and Handling Toolkit (cdc.gov) for proper placement of the probe within the cabinet to ensure proper performance.
- NSF 456 requires the temperature display probe (P4-RTD1 in REF20i and REF25i models) to be replaced or recalibrated. Follett recommends replacement/recalibration 12 months from the original date of calibration on the Certificate of Traceability supplied with your equipment at the time of purchase. Recalibration or purchasing a new calibrated probe is not covered by the original equipment warranty. To purchase a new Probe with Certificate of Traceability, please contact our Parts Department @ 1-877-612-5086 or partsales@follettice.com

1. Remove probe and cap from the top bottle and fill with glycerine supplied with unit (e.g., 50% glycerine and 50% water) (Fig. 4). Replace cap and reinsert probe sensor.
2. If equipped with a bottom probe, perform same procedure for bottom bottle.
3. Adhere supplied probe wire clips (x4, packaged with manual) to inside wall leading to the probe bottle.
4. Route probe wire into clips and close the clips.

Fig. 4

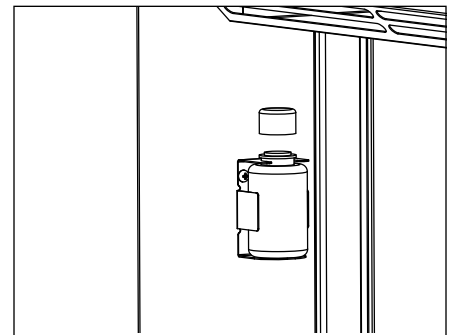

Alarm Output (optional)

The alarm output is a 12 Vdc signal that is turned ON when an alarm is activated. Connection is provided by a 2-circuit JST connector on the back of the control panel labelled **ALARM**.

Two connection options:

- The 12 Vdc signal can input directly into their system if their system is capable of receiving 12 Vdc.
- The output can be utilized to power a 12 Vdc relay (not included) to provide a NO/NC set of contacts.

Power the Unit

1. Press lower left corner of front facade door to access power switch inside (**Fig. 5.1**).

Fig. 5

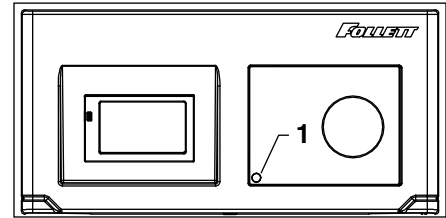

2. Press power switch to turn unit on (**Fig. 6.1**).
3. REF20i/25i units are equipped with rechargeable batteries. For units equipped with a chart recorder, the 9 V battery back up must be connected at the time of installation.

Fig. 6

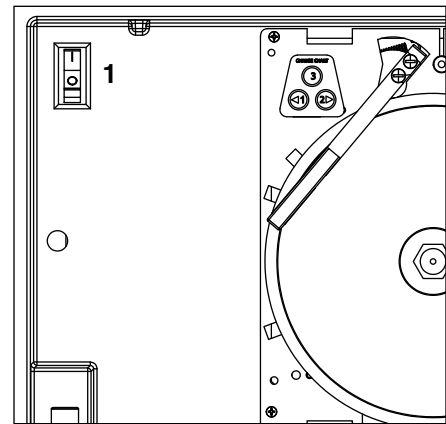

Controller Operation

Use and care of the LCD touchscreen

















The LCD touchscreen utilizes capacitive touch technology. This will allow you to engage the functionality by touching the screen with your fingers, even while you are wearing latex or cotton gloves. Functionality will not engage by touching with an inanimate object, such as a pen or stylus.

- To preserve optimal touch sensitivity, keep the screen clean by using a clean, dry cotton cloth.
- Do not expose the screen to liquids or excessive dust, heat or humidity.

Control function icons and navigation buttons engage functionality of the user interface. Status indicators alert the user to a change of status.

Home screen

The Home Screen consists of three primary information areas: the temperature display, control function display zone and system status display.

Control Functions	System Status	Functions and Settings
 Settings	 Compressor is running	 USB download available (downloading when blinking)
 Alarming	 Evaporator fan is running	 Refrigeration set points
 Light	 Door is open	 Sleep functions
 Information log	 Defrost cycle is in process	 Centigrade to Fahrenheit
 Help		 Probe set points
		 Alarming functions
		 Alarm mute
		 Reset

- Product temperature is displayed in the upper right corner.
- Current selected display probe above temperature readout.
- Primary control function icons are displayed in the lower left corner.
- System status icons will display in lower right corner to indicate a condition has been activated.



High and low temperature display

From the home screen touch the temperature display in the upper right corner. The high/low temperatures will appear below the temperature display. To the left of the high/low temperature, a time and date stamp will be displayed.

To view the bottom probe temperature and min/max temperature log

1. Press the Temperature Display in the upper right hand corner of the display - Will initially display MIN/MAX temperature of (P4) Top probe.
2. Press a second time to prompt a reset (P4) Top probe MIN/MAX.
 - This will reset both (P4) Top and (P5) Bottom probes.
3. Press a third time to display HIGH/LOW alarm settings.
4. Press a fourth time to display (P5) Bottom probe temperature.
5. Press a fifth time to display (P5) Bottom probe MIN/MAX.

Reset the high and low temperatures

Touch the temperature display a second time and the reset function  will appear under the high and low temperature. Touch the reset icon and a yellow message box will appear. Press  to confirm reset or  to cancel.

Alarm set point display

From the home screen touch the temperature display three times. The High and Low alarm set point will appear under the temperature. The factory preset alarm values are 2 C (35.6 F) and 8 C (46.4 F).

Fig. 7



Fig. 8



Fig. 9



Fig. 10



Help



- Help is available at any time by touching the  icon at the bottom of the screen.
- Help is screen-specific; touching the  icon will display an explanation of the functionality and use of the screen you are currently viewing.
- Touch  to exit help screen.

Fig. 11



Settings



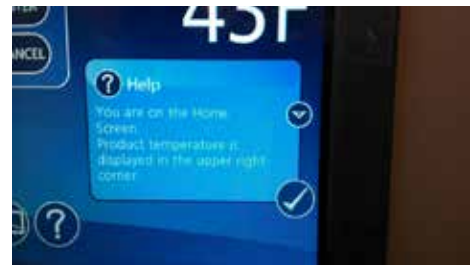







- Refrigeration Set Point 
 - Touch the number displayed in the box to the right of the Set point label and use the keypad or **UP** and **DOWN** arrows to select product temperature. Press  to accept or  to cancel.
- Sleep Temperature Display 
 - Toggle **ON** to hide the temperature reading immediately on the home screen.
- Set the Sleep Delay 
 - To automatically hide the temperature after 0-600 seconds of inactivity, touch the box to the right of the delay (0-600) box. Use keypad or **UP** and **DOWN** arrows to select from 0-600.
- Temperature 
 - Toggle between **F** and **C** to select Fahrenheit or Celsius.
- Brightness 
 - Touch the number displayed in the box to the right of the Brightness  icon and use the keypad or **UP** and **DOWN** arrows to select from 1-10. Press  to accept or  to cancel.

Fig. 12



Fig. 13



System Information



- Touch the System Info icon  to display the model number, unit serial number and software version. Touch the checkbox icon  in the lower right corner of the box to clear.

Fig. 14



Alarm or Alert Notifications





- If an alarm or event condition is detected and an alarm is engaged, an alert notification will appear in the left center of the screen with an explanation of the alert condition and a checkbox  at the bottom right of the alert box.
- No further action can be taken on the User Interface until the alert condition is acknowledged and cleared by touching the checkbox .
- Mute 
 - Touch the  icon to mute audible alarm for 10 minutes.

Fig. 15



High/Low Alarm

- This unit is equipped with a High and Low Temperature alarm that will give an audible and visual alarm immediately after the top probe falls out of range. The alarm will reappear every 10 minutes until the condition falls back into range.

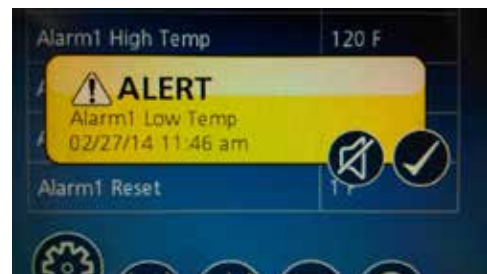
Door Switch

- This unit is equipped with a door switch that is located in the façade, and a magnet located on the top of the door. With the door closed, the switch reads closed. When the door is opened, the switch contacts open and turn on the LED lights.

Door Alarm

- This unit is equipped with a door ajar alarm that is factory set for 1 minute. In the event the door switch reads open for longer than 60 seconds (default) an audible and visual alarm will occur. The alarm will clear when the door is closed. The door alarm activation time can be changed from 0-600 seconds in the Advanced Settings Menu under Door Open Alarm Delay.

Power Alarm

- This unit is equipped with a Power Alarm that will sound if the unit loses power for more than five minutes. The Power Loss Alarm box will display every five minutes, then the screen will sleep. An audible alarm will sound every 30 seconds during the power failure. An alarm box will be displayed when power is restored. The event log will record the exact time and date of the power loss and when the power was restored.

Start-up alarm delay

This unit has a 120 minute time delay between when the unit is energized to when the temperature alarms become active. This delay can be changed in parameters in the controller under **Alarm Startup Delay**.

Setting Alarms









- Alarming Settings control the conditions and timing of event and alarm conditions that result in audible and/or visual alerts.
- To change the high alarm set point, touch the number displayed in the box to the right of the  icon and use the keypad or **UP** and **DOWN** arrows to select an alarm value. Press  to accept or  to cancel.
- To change the low alarm set point, touch the number displayed in the box to the right of the  icon and use the keypad or **UP** and **DOWN** arrows to select alarm value. Press  to accept or  to cancel.
- Audible Alarm 
 - Toggle between **ON** and **OFF** to engage and disengage the audible alarm function.
- Mute 
 - Touch the  icon to mute audible alarm for 10 minutes.

Fig. 16



Alarm Test Function

The Alarm Test Function is designed to drive the P4 reading above and below the programmed Alarm Set Points and validate the controller will signal an alarm. To perform the Alarm Test Function, follow the steps below:

1. Press the Gear Icon
2. Locate Advanced Settings
3. Enter Code 1,1,1,1
4. Scroll to General Alarm Setup Page
5. Select Test Hi/Low Alarms- Press Test
 - Controller will slowly elevate the Alarm probe temperature above the High Alarm Value until High Alarm appears on the screen along with an audible tone.
 - Controller will slowly lower the Alarm probe temperature until it falls below the Low Alarm Value until Low Alarm appears on the screen along with an audible tone.
6. Once the Test has been completed a record of the Hi/Low Alarm test will be viewable in the Event Log with a Time/Date stamp.

Probe calibration

- NSF 456 requires the temperature display probe (P4) to be replaced or recalibrated. Follett recommends replacement/recalibration 12 months from the original date of calibration on the Certificate of Traceability supplied with your equipment at the time of purchase. Recalibration or purchasing a new calibrated probe is not covered by the original equipment warranty. To purchase a new Probe with Certificate of Traceability, please contact our Parts Department @ 1-877-612-5086 or partsales@follettice.com

The temperature probes can be offset -9.9 to +9.9 in the Advanced Menu settings to deliver a more precise temperature reading.

1. Select Settings
2. Select Advanced settings and enter code 1,1,1,1. Confirm with Check mark
3. Using the DOWN arrow, scroll through Advanced Settings to Calibrate screen and select Calibrate
4. Place desired probe (P1-control, P2-Defrost, P4-Top probe, P5-Bottom probe) in an ice bath and allow 3-5 minutes for temperature stabilization.
5. Press "Offset" and use the UP/DOWN arrows to offset the probe reading to the proper value.

Note: In the event of a factory reset, the offset value will return to 0.

Screen saver

The screen saver will replace the home screen and display a blank screen, time and date, or the temperature. When the screen is touched or the unit has an alarm or event, it will return to the home screen. The screen saver can be changed in the advanced setting.

Screen saver function: blank, time and date, or temperature.

Screen saver time (sec): 0—600 seconds between the last touch of the screen to the activation of the screen saver.

Information Logs

- All available graphs, data logs and event logs are accessed through the Information Logs function. The home screen in the Information Logs section displays the product (P4) temperature graph with one week's data. Date and time information is displayed on the horizontal axis.
- This unit comes factory set to display only the product temperature (P4) on the graph. All of the probes can be viewed on the graph if desired. Probes can be added to the graph through the advanced setting under DATALOG. P1 and P5(if equipped) can be added by selecting the probe and changing the parameter from No to Yes. The selected probe will now display on the graph.
 - P1 control, P4 (Top Probe), P5 (Bottom Probe)
- Zoom in (+) or Zoom out (-) on an event/temperature on the home screen will change the time scale.
- Using the left and right arrows below the graph will scroll the graph. All the stored temperature data on the graph is viewable.
- Temperature Log – to display a chronological listing of logged temperatures (latest logged temperature will display first), touch the **Temperature Log** label to the left of the screen. Use the **UP** and **DOWN** arrows to the right of the screen to scroll through the logged temperatures.

Fig. 17

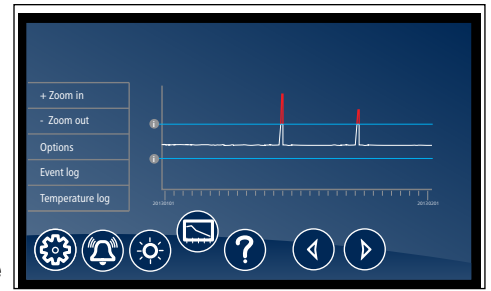
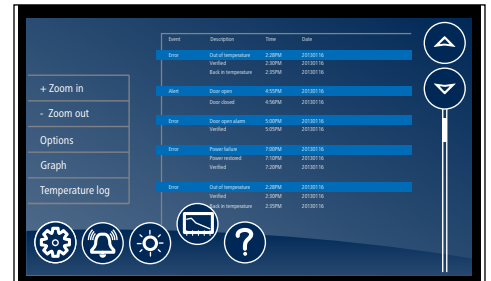

Fig. 18



- Event Log – to display a chronological listing of events (including errors, alarms and alerts), touch the **Event Log** label to the left of the screen. Use the **UP** and **DOWN** arrows to the right of the screen to scroll through the logged temperatures.

Fig. 19



Data logging

- The controller is capable of storing up to 50,000 readings per probe. The factory setting for the sample rate is every 15 minutes, which will provide enough storage for 520 days. The sample rate can be change to provide data logging for a longer or shorter time interval by changing the **Sample Rate (Min)** in the advanced settings menu. **0 = off and 360 minutes maximum.**

Data Storage

- Data can be captured different ways. The factory default is for the data to overwrite itself when the memory is full. This can be changed in the advanced setting under **Data storage overwrite**. When this parameter is set to **No**, the system will display an alert when the memory is 75% full. To clear the alert the data must be downloaded.

Data duration alarm

- A reminder can be set to download the data in the **Data duration alarm** in the advanced setting. The data duration can be set from **1 to 180 days**. If the data duration alarm is used, then the **Alarm on data full** parameter in the advanced setting must also be set to **Yes**.

Downloading data

- The touchscreen has the capability of downloading the temperature data and event log via a USB port on the left side of the user interface. The file is a CSV format and is suitable for import directly into Microsoft Excel.

1. Insert the storage device in the USB slot located to the left of the Touchscreen.
2. Select the Graph icon along the bottom of the Touchscreen.
3. Select the USB icon in the lower right hand corner.
4. A yellow alert box with **downloading data** will appear.
5. Press to accept or to cancel.
6. After the unit is done downloading a second yellow alert box will appear asking if you want to **Erase log**.
7. Press to accept or to cancel.

Note: If you chose to erase the data, the data duration timer and the data full alarm will reset. It will also erase the information that is stored on the graph.

One of the two files below will be downloaded depending on which screen is being viewed:

EL XXXX YY - Event Log

TL XXX YY - Temperature Log

XXXX = last 4 digits of serial number

YY = 0-99 number of downloaded file

Data download reminder and data full alarm

- If you plan or are required to download data for a certain time period, you can set a **download data reminder** on the Performance Plus unit. Download data reminder can be found in the advanced setting under **Data duration** and can be set from **1 to 180 days**.

Follett Keypad Lock – (Optional)

For units equipped with the electronic lock accessory option, a keypad will be displayed on the left side of the touchscreen. In order to gain access to the storage area, a user code must be entered.

- User default code is factory set to 1,2,3,4,5,6 and is stored in memory slot 01.

Fig. 20









Fig. 21



Fig. 22



Changing and Adding the User Codes

1. Touch Settings  icon.
1. Touch **Advanced Settings**, enter your 4-digit user access code (factory default is 1 1 1 1) in the keypad that appears, and touch the checkmark icon  to access advanced settings screens.
2. Time and date will be displayed. Scroll using the **UP** and **DOWN** arrows until **Change Access Code** is displayed in the Display Setup screen.
3. Touch **Change Access Code** and enter the master code [ENTER]. (By default, the master code is 1 2 3 4 5 6.)
4. Touch the screen to the right of the user code 2 to 40 to overwrite or add the user code.
5. Enter the new code. Press  to accept or  to cancel.
6. Enter the new code again. Press  to accept or  to cancel.
7. Press **DONE** when finished entering access codes.











Electronic Lock Override

- Insert key, turn lock.
- Remove panel.
- Depress plunger with screwdriver.

Light

- To turn the interior light on (or off), touch the Light icon or the Light Off icon.
- Light timer is in advanced settings.
- The light will also come on when the door is open.

Time and Date

- To set time and date, press the Settings  icon.
- To display options, touch **Advanced Settings**, enter your 4-digit user access code in the keypad that appears, and touch the checkmark icon  to access advanced settings screens (factory default is 1111).
- Time: touch displayed time and use the keypad to enter the time. Press  to accept or  to cancel.
- AM/PM: touch displayed value to toggle between AM and PM.
- Month: touch number displayed and use the keypad to enter the month. Press  to accept or  to cancel.
- Day: touch number displayed and use the keypad to enter the day. Press  to accept or  to cancel.
- Year: touch number displayed and use the keypad to enter the year. Press  to accept or  to cancel.

Advanced Settings

- Touch **Advanced Settings**, enter your 4-digit user access code in the keypad that appears, and touch the checkmark icon  to access advanced settings screens (factory default is 1111).

Fig. 23

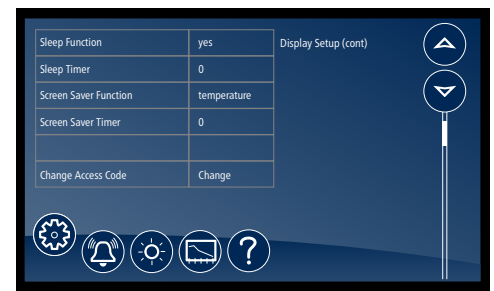

Fig. 24

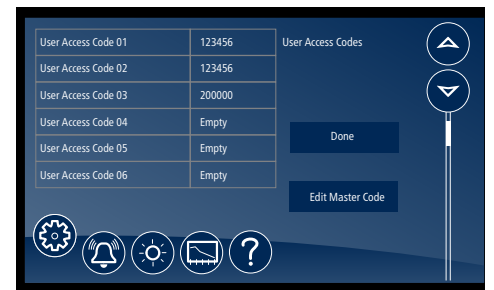

Fig. 25

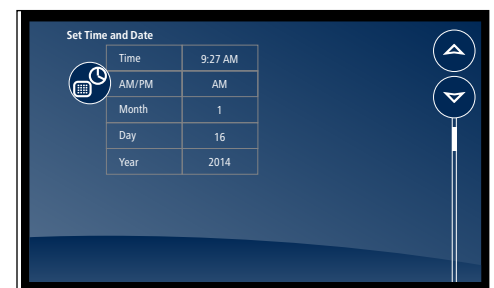

Chart recorder set up (if so equipped)

The chart recorder is mounted in the front right of the facade behind the door (**Fig. 26**). A package of 50 charts that record in C is included with your refrigerator. If you have changed your display to show temperatures in F, you will need different charts. Please call Follett at (877) 612-5086 or +1 (610) 523-9361 to order part number 00967729.

The chart recorder is powered by the controller and has its own battery back up. An LED provides battery status info: Steady green = battery okay, Flashing green = low battery or no power to the controller.

Chart recorder calibration

If desired, calibration should be done at the same time as probe calibration by pressing either the left or right arrow keys to correspond with the calibrated product display temperature.

1. Press **Left #1** or **Right #2** arrow button for 5 seconds until pen begins to move.
2. Continue to press **#1** or **#2** button to move pen to record same temperature as probe.

Changing the chart paper

1. Press and hold **#3** button until pen begins to move off chart.
2. Once the pen moves completely off chart, unscrew knob (counter-clockwise) at center of chart.
3. Remove old chart and place new chart in position so that correct time coincides with time line groove on recorder.
4. Reinstall knob.
5. Press and hold **#3** button for approximately (1) one second until pen begins to move back onto chart.
6. Make sure pen is marking paper. If not, carefully adjust arm so that pen makes contact with paper.

Replacing the pen

1. To replace pen, press and hold the **#3** button until pen starts to move off chart.
2. Once pen has moved completely off chart, carefully lift pen up and unsnap the "U" clip part to remove pen from metal pen arm.
3. Position new pen on metal pen arm and snap "U" clip underneath pen around arm to secure.
4. Press and hold **#3** button for approximately (1) second until pen begins to move back onto chart.
5. Make sure pen is marking. If not, carefully adjust arm so that pen makes contact with paper.

Removing drawers

1. Pull drawer forward to stop (**Fig. 27.1**).
2. Lift drawer front to free front rollers from slides (**Fig. 27.2**).
3. Still lifted, pull drawer forward to free back rollers from slides.

Fig. 26

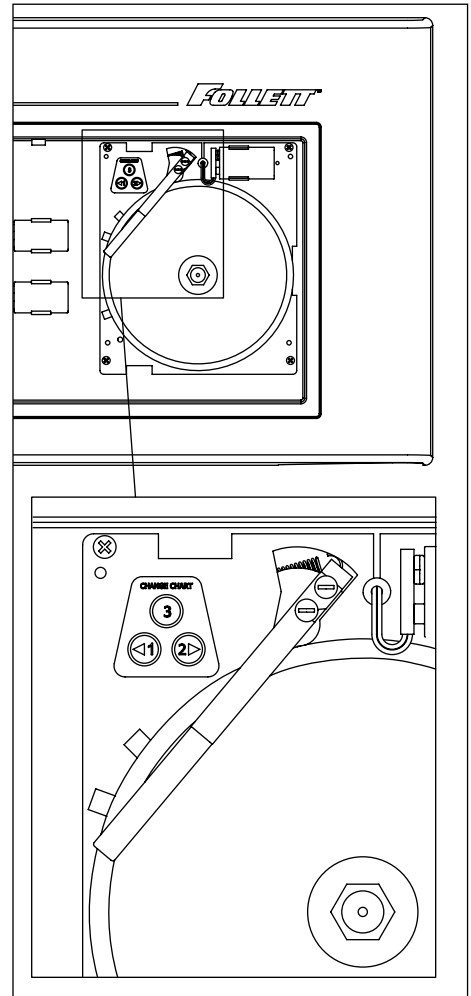
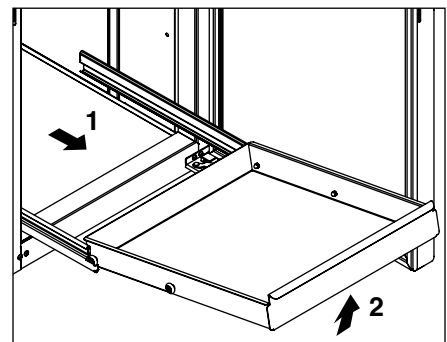

Fig. 27



Removing slides

1. Push slides all the way back.
2. Swing bottom of slide away from refrigerator wall and lift slide off rollers.



Network Enabled Device

For assistance with Network Enabled Devices, please scan the QR code. This code can also be found behind the access door on the REF20i/25i, and on the inside cabinet wall of the REF12i.

Scan the QR code for help with Wifi Temperature monitoring setup.		 DicksonOne™		01541119R00
---	---	--	--	-------------

Rechargeable Battery

Your refrigerator is equipped with a rechargeable SLA AGM 12 V 1.2Ah battery. The unit also includes a charger which maintains battery charge in readiness of a potential power failure event.

 CAUTION	
	<ul style="list-style-type: none">▪ Risk of hazard if non-rechargeable or otherwise improper battery is installed in the system.▪ If battery maintenance is required, use only appropriate Follett-authorized service part or compatible SLA AGM 12 V 1.2Ah battery.

Cleaning

Use non chlorine-based cleaners. Cleaners containing chlorine can cause staining and pitting of the stainless steel.

Disconnect power to unit by turning the power switch off, located on the upper front facade panel, and removing the power cord from the receptacle.

Interior cleaning

Using a sponge or soft cloth, clean unit with a non-abrasive, non-chlorinated, all-purpose detergent. Note: The air plenum should be removed to clean it, as well as behind it (**Fig. 28, 29**). In addition the shelves, baskets, drawers and slides should be cleaned as well.

Exterior cleaning

Wipe stainless steel exterior with a soft cloth in the direction of grain as needed. Stainless steel polish may be used to enhance the finish of the unit. The glass door and exterior parts may be cleaned with a soft cloth, window cleaner or other non-abrasive cleaner.

Fig. 28

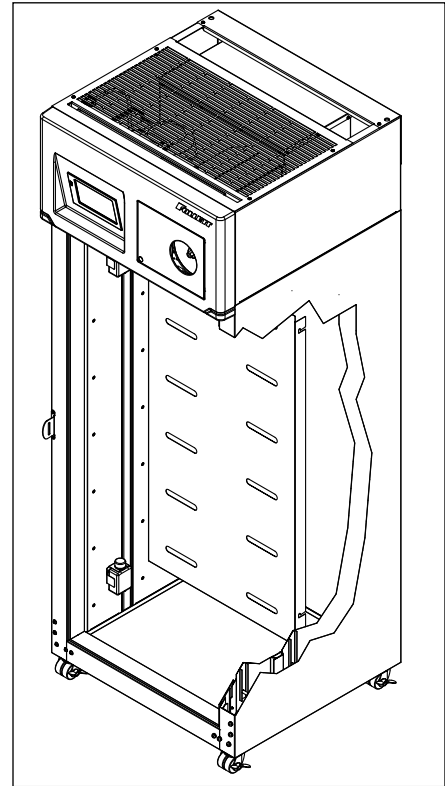
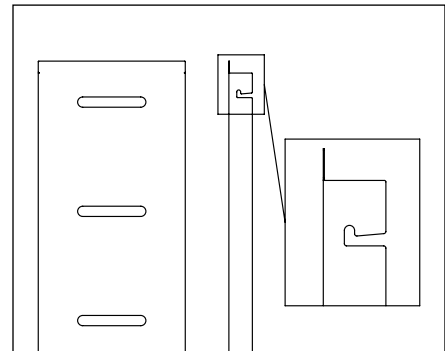

Fig. 29



Annual cleaning

Removal of dust and other particulates from air intake areas and the condenser is important for proper operation. Environments with large amounts of dust may require more frequent cleaning.

1. Disconnect power to unit by turning power switch off (located on upper front facade panel) and removing power cord from receptacle.
2. The condenser can be accessed from top for cleaning. The side panel in front of condenser may be completely removed for easier cleaning by disconnecting facade and removing upper side panel. See Facade Removal for facade removal instructions.
3. Inspect drain pan for any debris or obstruction in condensate pan (**Fig. 30.1**).
4. Use a vacuum cleaner with brush attachment to clean condenser, compressor and related parts.
5. Reinstall upper side panel and facade if removed.

Fig. 30

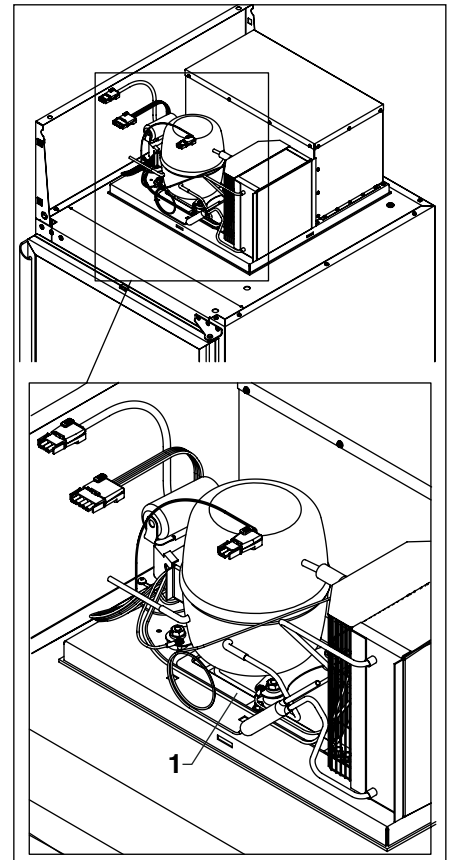

Defrosting

REF20i/25i model refrigerators incorporate an auto defrost cycle. The refrigerator enters a defrost every 8 hours.

The defrost cycle will terminate when the evaporator coil probe (P2-Evaporator) reaches 5.5 C (42 F) or when 30 minutes has elapsed, whichever comes first.

Antifreeze Function

The Antifreeze Function is designed to keep the stored vaccines from falling below 2 C (36 F). The function is driven by the P4-RTD 1 bottle probe. In the event that the P4 probe reading reaches 2 C (36 F), the cooling system will cycle OFF. Once the P4-RTD1 probe reading rises back to the programmed controller Set Point, the cooling system will cycle back on and assume normal operation.

Folletts Patented P.I.D. Controller

Folletts patented P.I.D. controller allows the control system to modulate the RPMs of the compressor and condenser fan according to cabinet requirements. The evaporator fan runs at a consistent RPM value during cooling system operation.

Proportional Control Operation - Primary

As the return air (P1 probe) reading rises above the set point value, the compressor and condenser fan RPMs increase to provide additional cooling capacity.

As the return air (P1 probe) value approaches set point, the compressor and condenser fan RPMs reduce.

As the return air (P1 probe) reading falls below the set point, the compressor and condenser fan RPMs will operate at minimum levels to sustain product and cabinet temperature.

The compressor and condenser fan RPMs will continue to increase and decrease to sustain desired set point.

Integral Control Operation - Secondary

As a secondary to the Proportional Control, the Integral Control Operation also analyzes the amount of time that the return air (P1-Control) has been above or below set point value. In tandem with the Proportional Control, it adjusts compressor and condenser RPMs to sustain cabinet temperature.

Derivative Control Operation - Tertiary

As a tertiary control function, the Derivative Control Operation monitors return air (P1-Control) specifically identifying sudden increases and decreases in return air temperature and, when identified, will adjust RPMs accordingly.

ATTENTION
<i>Cabinet temperature adjustments can be made by simply modifying the temperature control setpoint. Modifications to the factory default settings will result in excessive compressor cycles and may lead to premature failures. Component failures caused by adjusting critical control parameters may void the equipment warranty.</i>

Sensor Readings/Temperature Display

The Touchscreen is defaulted to display the P4-Top probe which reads the solution temperature of your product simulation bottle. For ease of troubleshooting, the Touchscreen can be toggled to display the P1-control probe to view the refrigeration cycle. To toggle the display for your desired probe, Access Advanced Settings>Display Probe and select the desired probe.

Note: After service is complete it is recommended to restore the display to the P4-Top Probe.

Heated door (option)

Heated doors are factory installed. An unheated door cannot be retrofitted to a heated door in the field. Factory default for the heated door and fascia heater cycle is set to 10 minutes off and 10 minutes on.

Should the need arise, the door schedule can be changed in Advanced Menu>Door Heater.

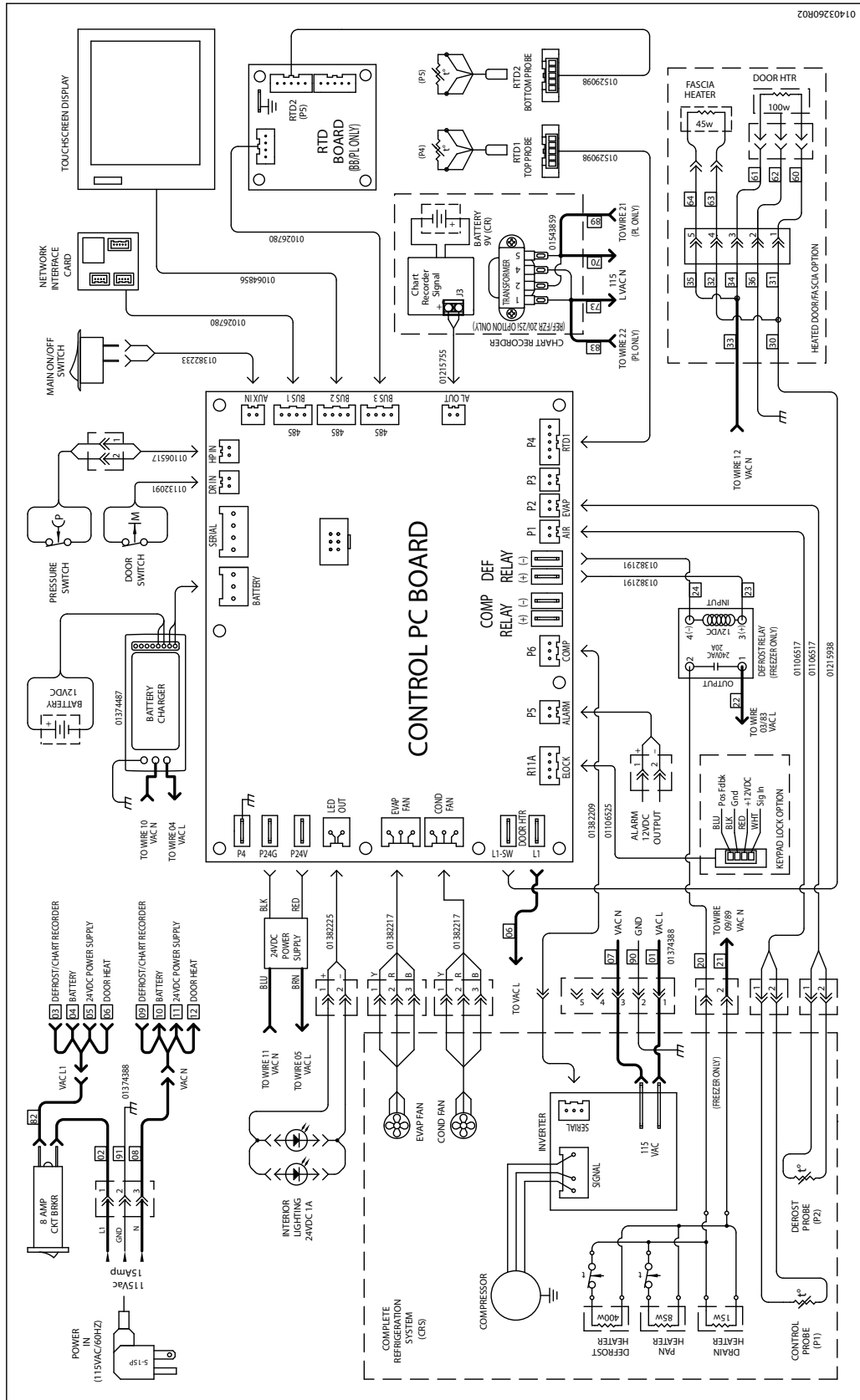

01403260M02

Facade removal

CAUTION



- The following terminals are hazardous live:
 - PWR IN
 - Inverter/Comp
 - Defrost Heater
 - Door Heater
 - (45) Door Heater

1. Locate the façade door to the right of the controller display. Press and release the lower left corner of the façade door to open. Locate ON/OFF switch and turn to OFF position.
2. Remove top ventilation cover.
3. Disconnect all wiring harnesses attached to the rear of the façade.
4. Open refrigerator door and locate the two screws on the underside of the façade. Remove and retain screws.
5. Gently pull the plastic façade cover forward approximately 1.5", separating the bayonet mounts from the sides of the side support panels (**Fig. 31**).

6. Lift and pivot the bottom of the façade upwards to just above horizontal, and allow it to track on the façade hinge (**Fig. 32**).

Fig. 31

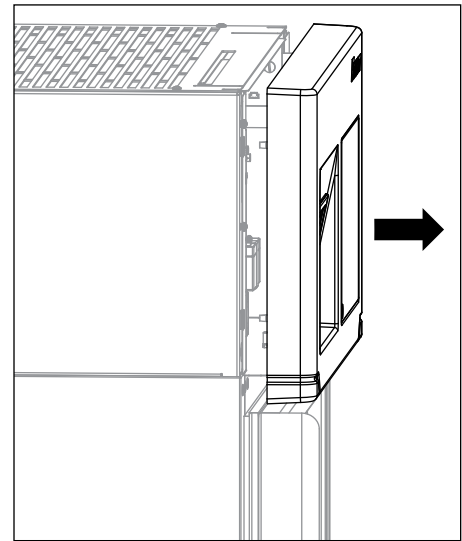
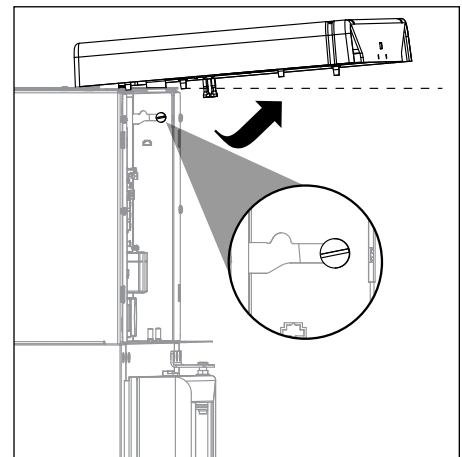
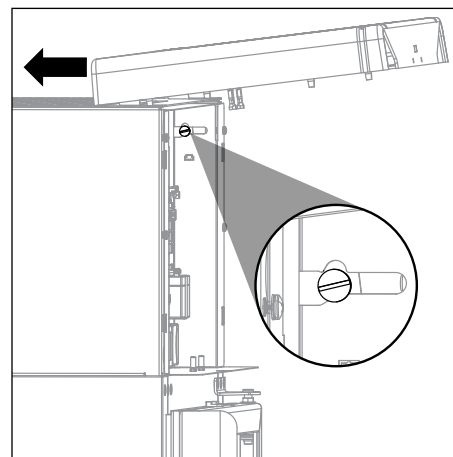

Fig. 32



7. Slide the façade hinge towards the rear of the cabinet allowing the hinge pin to slide within the groove until the top male bayonet pin rests on the top of the electrical control box (**Fig. 33**).
8. Continue sliding front façade towards back of cabinet, until it rests entirely on top of unit.

Fig. 33



9. Remove two screws on both the left and right side that secure the electrical control box to the side support panels (**Fig. 34**).
10. Carefully grab the plastic front façade and bring it down to meet the rear of the façade.
11. While holding the front of the façade, grip the rear façade left/right tabs and entirely remove from cabinet.
12. Carefully close façade.
13. Reinstall vertical screws through façade cover.
14. Pull façade assembly away from cabinet.

Fig. 34

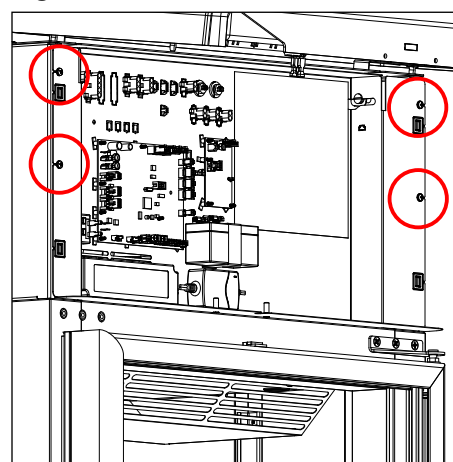

Controller replacement

⚠ CAUTION



- **Controller board is susceptible to electrostatic discharge. Extreme care should be exercised by using a grounding strap when handling and installing control board.**

Fig. 35

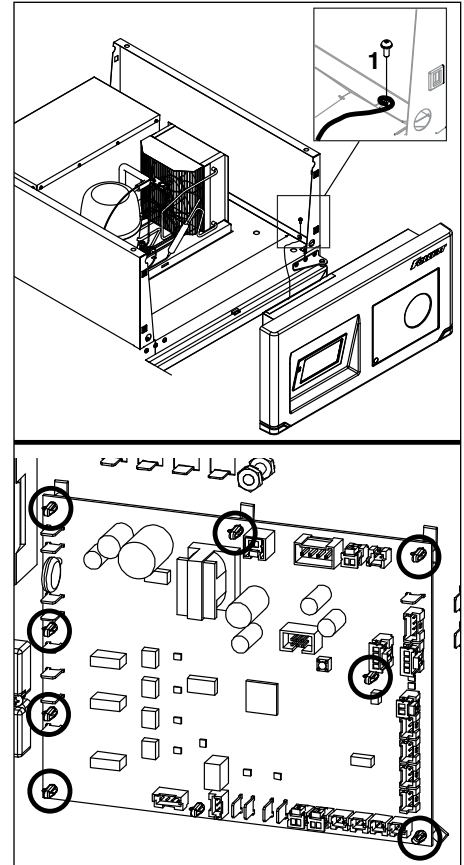

1. Turn off power to unit and unplug.
2. Disconnect electrical plugs and remove facade.
3. Remove screw securing ground screw to refrigerator cabinet (**Fig. 35.1**). Do not remove ground wire from facade.
4. Place facade face down on flat clean surface with bottom of facade facing you, and remove four screws attaching back panel to facade.
5. Lift and rotate back panel toward you.
6. Take precautions for proper grounding to reduce risk of electrostatic discharge (ESD) to the controller board.
7. Locate the control board standoffs (**Fig. 35.2**).
8. Using Needle nose pliers, pinch the stand-off tabs and gently pull up on the control board to release.
Note: All wiring should remain connected to the original control board at this time.
9. Install replacement control board on existing stand-offs.
Note: Use supplied stand-offs to replace any that may have been damaged during control board removal.
10. Removing one at a time, transfer wiring from the original control board to the replacement control board, ensuring each wire is secured at the same location it was removed from.
11. Flip façade cover back into position on façade and reinstall 4 screws.
12. Remount façade to bayonet mounts.
13. Reconnect ground wire to grounding location on cabinet.
14. Reconnect all electrical and probe connections.
15. Plug in unit and power on, ensuring proper operation.

Reversing the door swing (requires a new door)

REF20i/25i units ship standard with a non heated right hinged door. To change to a left hinged configuration requires a new door. For heated door options other parts may be required. If the unit has a heated door option consult technical service by calling (877) 612-5086 or +1 (610) 252-7301.

Door gasket replacement

1. Remove existing gasket from mounting track (**Fig. 36**).
2. Verify mounting track is free of any remaining gasket material.
3. Align new gasket with mounting track and press firmly in place.
4. Open and close door, checking for proper gasket seal without pinching against refrigerator.

Fig. 36

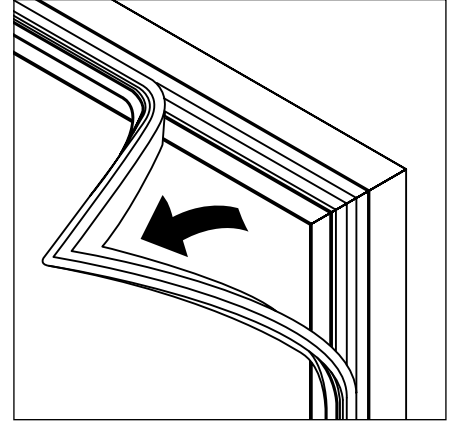

Slide-out unit cooler

Follett's slide-out refrigeration system allows technicians to remove the entire unit from the refrigerator top.

1. If necessary remove facade and upper side panels.
2. Remove four bolts securing unit cooler to refrigerator top (**Fig. 37**).
3. Gently lift off cooler.

Fig. 37

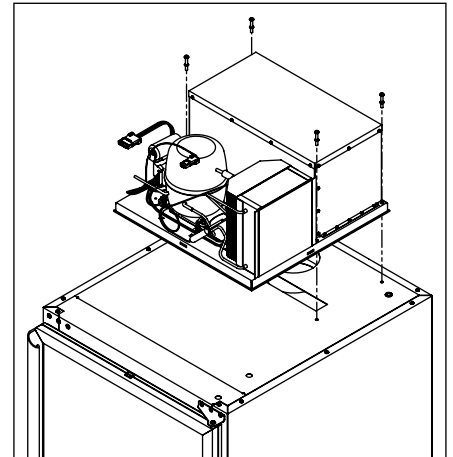

Refrigeration System

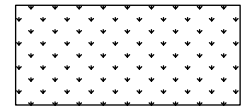
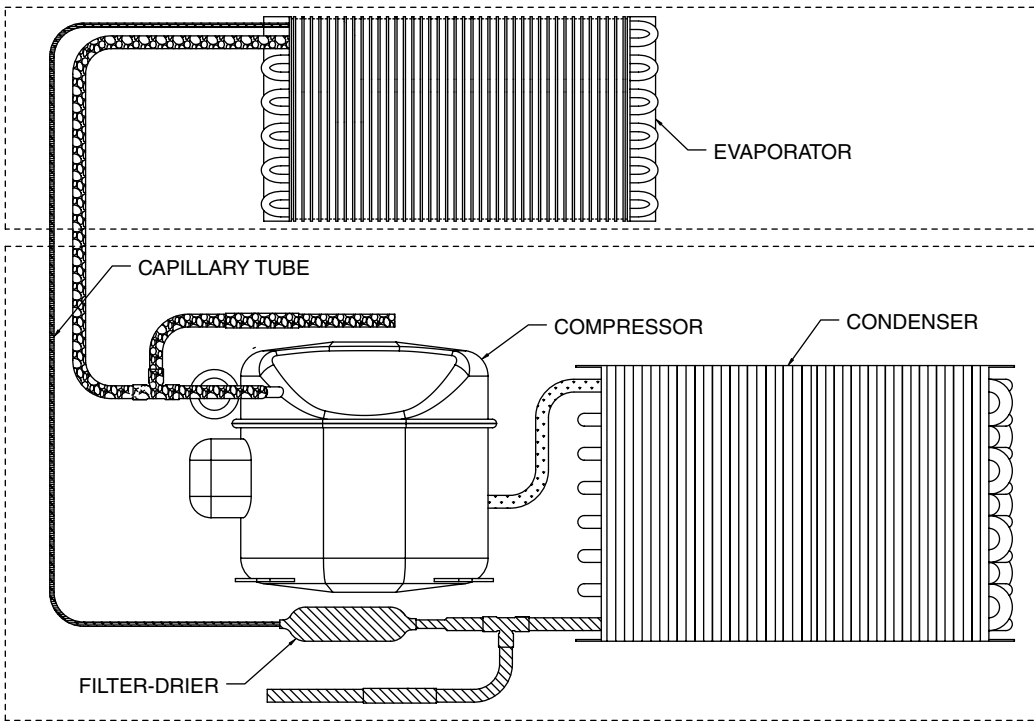

HIGH PRESSURE VAPOR

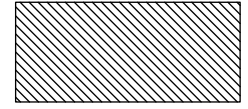

HIGH PRESSURE LIQUID

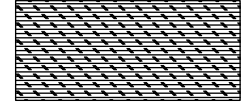

LOW PRESSURE LIQUID

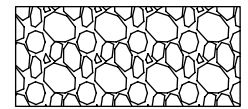

LOW PRESSURE VAPOR

Advanced Setting - touchscreen

Parameter	Default Value	Range	Description
Set Time and Date			
Time	7:45	0 to 12	Holds Hour
AM/PM	AM	AM, PM	Holds AM/PM
Month	12	1 to 12	Month
Day	16	1 to 31	Day
Year	2013	2010 to 2099	Year
System Information			
Serial Number	E12345	—	—
MC Version	33	—	MC version
UI version	17	—	UI version
Display Setup			
Beeper Function	ALL	Off, All, dr, Alr, Err	Controls the audible beeper function on the controller. Off (all off), All (all on), Door (dr), Alarm (Alr), Error (Err).
Beeper Volume	5	0 to 10	Beeper.
Button Clicks	Yes	Yes, No	Sets if a beep should sound each time a button is pressed.
Display Probe	RTD1 (P4)	Control (P1), Defrost (P2), P4, P5	The probe to display on controller.
Resolution	Dec	Int, Dec	Integer or decimal
Sleep Function	Yes	Yes, No	Sleep function will blank the screen after 0 to 600 seconds of non-use.
Sleep Timer	0 seconds	0 to 600 seconds	Amount of time before the screen blanks automatically.
Screen Saver Function	Temperature	Blank, temperature, date/time	Screen saver function will hide the home screen. It will display a blank screen, temperature, or time and date.
Screen Saver Timer	0 seconds	0 to 600 seconds	Amount of Time before the screen saver initiates.
Change Keypad Access Code	Change	—	Allows entry/editing of keypad access codes. Password required.
Control Setup (REF)			
User Set Point	4.4 C	LSP-USP	The temperature setpoint that the user adjusts.
Upper Setpoint	10 C (50 F)	—	Upper range of user-adjustable setpoint.
Lower Setpoint	2 C (36 F)	—	Lower range of user-adjustable setpoint.
Lock Setpoint Adjustment	Unlocked	Unlocked, locked	Locks the setpoint C/F, and alarm high/alarm low against accidental changes.
Import Parameters	No USB drive	No USB, import parameters	Import parameters from a USB port.
Export Parameters	No USB drive	No USB, export parameters	Export parameters from a USB port.
Keypad Present	No	Yes, No	Defines if product has keypad door lock.
PID Time Interval	10	1 to 120 seconds	Time interval between changes in compressor and fan speeds.
AntiFreeze Enable	Yes	Yes, No	Determines whether the AntiFreeze function is enabled.
AntiFreeze Temp	2 C (36 F)	30 to User Set Point	Determines temperature at which AntiFreeze will activate.
AntiFreeze Delay	0	0 to 240 seconds	Once P4 reaches AntiFreeze Temp, amount of time to wait before activating AntiFreeze function.

Parameter	Default Value	Range	Description
Alarm Setup			
Alarm 1 Delay	1 minute	0 to 60 minutes	Alarm1 delay before sounding.
Alarm 1 Function	rA	No, rA, disabled	Defines the action when Alarm 1 is activated. Display only (No), Display and Remote Alarm (rA), No action (disabled).
Alarm 1 High Temp	8 C (46 F)	User Set Point to 150	High temperature to activate Alarm 1.
Alarm 1 Low Temp	2 C (36 F)	-50 - User Set Point	Low temperature to activate Alarm 1.
Alarm 1 Probe	Alarm (P4)	RTD1, airReturn, evaporator	Probe for Alarm 1.
Alarm 1 Reset	1	0 to 10	Temperature difference to reset Alarm 1.
General Alarm Reset			
Alarm Ringback	10 minutes	0 to 120 minutes	Defines the time delay until the alarm will resound.
Alarm Startup Delay	120 minutes	0 to 180 minutes	Defines the alarm delay during startup.
Alarm Silencing	Yes	Yes, No	Determines if the alarms can be silenced or not.
Maintain Alarm	Yes	Yes, No	Determines if the alarm should be maintained if the temperatures fall back into range.
Test Hi/Lo Alarm	Test	-	Initiate a simulated High and Low alarm test.
Test Alarm	Test	-	
Door Control			
Door Open Alarm	Yes	Yes, No	Sound beeper when door alarm activated.
Door Open Alarm Delay	60 seconds	0 to 300 seconds	Door open alarm delay.
Door Open Remote Alarm	rA	RTD1, airReturn, evaporator	Defines action when door open alarm activated. Display only (No), Display and Remote Alarm (rA), No action (disabled).
Door Fan control	Yes	Yes, No	Defines if the evap fan should shut off when the door is open.
Door compressor time	200 seconds	0 to 300 Seconds	Defines the time to shut off the compressor after the door is open. 0 = ignore
Light control			
Turn light on/off with door	Yes	Yes, No	Turn light on/off with door openings.
Light off timer	120 seconds	0 to 600 Seconds	Turn off the light after XX seconds
LED Light Control	LEDLightMosfet	-	LED output designation.
Power Alarm			
Power Alarm	Yes	Yes, No	Defines if an alarm should sound if power is lost.
Power Remote Alarm	Yes	Yes, No	Defines if remote alarm should activate on power alarm.
Power Alarm Timer	5 minutes	0 to 120 minutes	Delay before sounding the power alarm.
Battery Level			Battery Level
Battery Backup	Rechargeable	Rechargeable, Standard	Determines if type of backup battery is rechargeable or standard.
Recharge Delay	120	0 to 300 seconds	When

Parameter	Default Value	Range	Description
Data log			
Sample Rate	15 minutes	0 to 360 minutes	minutes between data sampling. 0 = Off
Data Duration	90 days	1 to 180 days	Duration to keep data log.
Data Storage Overwrite	Yes	Yes, No	Overwrite circular data?
Data Full Alarm	No	Yes, No	Alarm when data memory is full?
Track Events	Yes	Yes, No	Track events with log
Display System Events	Yes	Yes, No	Determines if non-alarm system events are shown in the event log.
P1 Datalog	No	Yes, No	Log P1 to event log
P2 Datalog	No	Yes, No	Log P2 to event log
P3 Datalog	No	Yes, No	Log P3 to event log.
P4 Datalog	Yes	Yes, No	Log P4 to event log
P5 Datalog	No	Yes, No	Log P5 to event log
RPM Datalog	No	Yes, No	Log Compressor RPM to event log.
CFan Datalog	No	Yes, No	Log Condenser Fan PWM percent to event log.
EFan Datalog	No	Yes, No	Log Evaporator Fan PWM percent to event log.
Defrost			
Manual Defrost	Initiate	–	Force the unit into a defrost
Defrost Function	PowerOn	PowerOn, CompressorOn, TimeOfDay, ManualOnly, Disabled	Defines tactic for initiating a defrost
Defrost Tactic	Evaporator	Evaporator, ElecHeat, HotGas	Defines type of defrost.
Defrost Termination Tactic	Temperature	Temperature, Duration	Defines defrost end routine.
Defrost Timer	8	2 to 720 hours	Time between defrost cycles.
Defrost Termination Temp	41	0 C to 66 C (32 F to 150 F)	When termination tactic is set to Temperature, defines this temperature.
Defrost Duration	30	0 to 60 minutes	When termination tactic is set to Duration, defines this duration.
Evap Fan Defrost Delay	0	0 to 500 seconds	After a defrost concludes and drip time concludes, amount of time to delay restart of evap fan.
Drip Timer	0	0 to 300 seconds	After defrost concludes, amount of time to delay restart of compressor and condenser fan.
Evap Fan Restart	Time	Time, Temperature	Defines if evap fan should restart based on time or temperature at the conclusion of a defrost cycle.
Evap Fan Temp	30	-40 C to 15 C (-40 F to 60 F)	After defrost concludes and drip time concludes, temperature to reach before restart of evap fan.
Evap Fan Defrost PWM Percent	50	0% to 100%	Defines fan speed during an evaporator fan defrost.

Parameter	Default Value	Range	Description
Graphing			
X Axis Range (hrs)	168 hours	1 to 384 hours	Time span for x-axis
Y Axis Minimum	-1 C (30 F)	-46 to 121 C (-50 to 250 F)	Minimum temperature shown on graph
Y Axis Maximum	27 C (80 F)	-46 to 121 C (-50 to 250 F)	Maximum temperature shown on graph
Graph Show Alerts	No	Yes, No	Determines whether alerts are displayed on the graph
P1 Graph Display	NO	Yes, No	Determines whether to graph probe 1
P2 Graph Display	No	Yes, No	Determines whether to graph probe 2
P3 Graph Display	No	Yes, No	Determines whether to graph probe 3
P4 Graph Display	No	Yes, No	Determines whether to graph probe 4
P5 Graph Display	No	Yes, No	Determines whether to graph probe 5
Door Heater			
Door Heater	UR REF with Heated Glass Door: Yes All others: No	Yes, No	Controls door heater output
Door Heater Off (mins)	UR REF with Heated Glass door: 10	0 to 100	Off time for door heater if dht = on
Door Heater On (mins)	UR REF with Heater Glass door: 10	0 to 100	On time for door heater if dht = on
Door Heater Threshold	50	0 C to 49 C (32 F to 120 F)	Control probe temperature below which the door heater function is engaged.
Probes			
Probe Error	BPr	NO, BPr, R1 relay, R2 relay	Action to take when probe error detected
Control On Time (mins)	UR REF: 4	0.0 to 120.0 minutes	Compressor on time when control probe error (minutes)
Control Off Time (mins)	UR REF: 8	0.0 to 120.0 minutes	Compressor off time when control probe error
Probe Calibration	Calibrate		Calibrate probes through a second menu
Viewable			
Probe Readings	View		View current temperature value of probes 1-5.
Power On Time (hrs)			View cumulative hours that the unit was in service
Compressor cycles			The number of compressor starts
Toal Comp Time (hrs)			View cumulative hours that the compressor was energized
Compressor RPM			Current compressor speed (RPM).
Cond Fan PWM Percent			Current condenser fan speed (%).
Evap Fan PWM Percent			Current evaporator fan speed (%).
PPIDCC View			View detailed control parameters.

Parameter	Default Value	Range	Description
Software			
Reset	No	Yes, No	Set to Yes to reset all parameters back to factory default. Does not change keypad codes.
Change Adv Settings Code	Change		Change the digit code used to access the advanced settings menu.
Download Log File			Downloads system log to a USB drive.
Keypad Access Log			Downloads keypad log to a USB drive.
Erase Data Log	Erase		Clears the contents of the data log.
Software Update	Update		Updates the touchscreen software and main control board software.
Analog Out			
Analog Out 1	P4	P1, P2, P3, P4, P5, 5vdc	Defines which probe should be tracked with analog out, or set to constant 5 VDC.
Analog Upper Range	25 C (77 F)	-1 C to 38 C (30 F to 100 F)	Upper limit for analog output.
Analog Lower Range	-5 C (23 F)	-45 C to -2 C (-50 F to 29 F)	Lower limit for analog output.
Analog Battery Power	Yes	Yes, No	Determines if analog output should be powered during a loss of AC power.
Advanced Setup			
Probe 1 Presence	Yes	Yes, No	Defines if Probe 1 is present.
Probe 2 Presence	Yes	Yes, No	Defines if Probe 2 is present.
Probe 3 Presence	No	Yes, No	Defines if Probe 3 is present.
Probe 4 Presence	Yes	Yes, No	Defines if Probe 4 is present.
Probe 5 Presence	No	Yes, No	Defines if Probe 5 is present.
Input 1 Config	DoorOpen	DoorOpen, HPS, Disabled	Defines Input 1.
Input 2 Config	HPS	DoorOpen, HPS, Disabled	Defines Input 2.
Network Device Present	Yes	Yes, No	Determines if the Network Interface Device is present.
Bluetooth Enabled	Yes	Yes, No	Determines if the Bluetooth signal is enabled.

Replacement parts

Unit cooler (Embraco - Black Evaporator Cover)

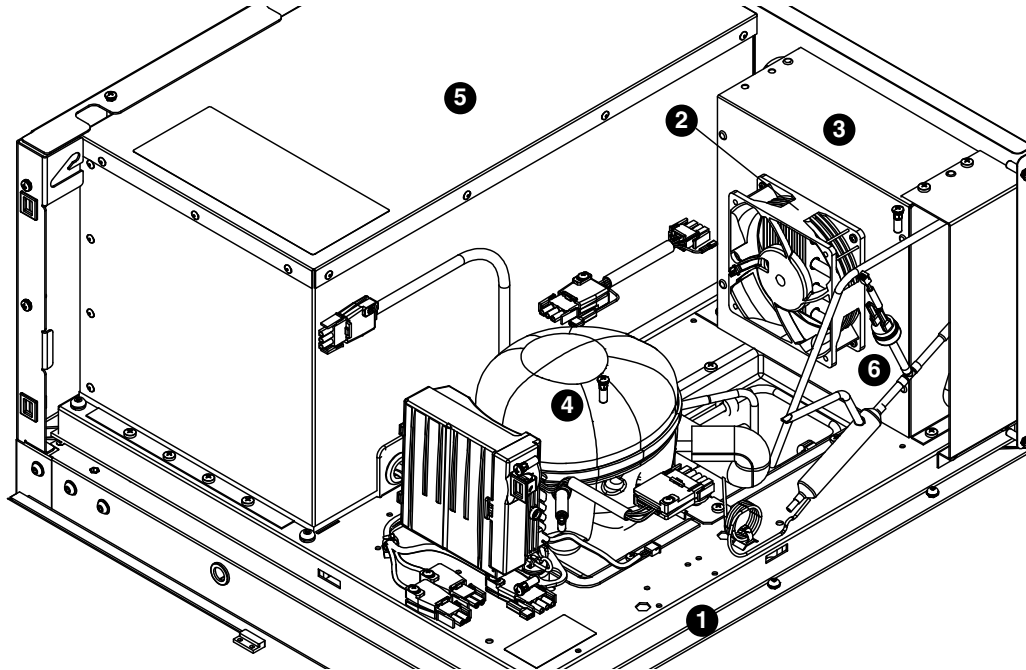

Reference	Description	Part #
Not shown	Gasket, unit cooler	00912980
Not shown	Probe, NTC, air return/evaporator	01552496
1	Cooling module, Infinity Series refrigerator, includes mounting bolts and gasket	01548791
Not shown	Evaporator fan, 24 Vdc, variable speed	01539733
2	Condenser fan, 24 Vdc, variable speed	01552546
Not shown	Filter drier	01334069
3	Condenser with drier	01334101
4	Compressor, Infinity Series refrigerator, includes drier	01539717
5	Evaporator with drier	01334044
6	Pressure switch and drier	01552538
Not shown	Cord and plug kit	00939900
Not shown	Hose, condensate drain	01334036
Not shown	Condensate pan	01334093
Not shown	Cover, evaporator	01334242
Not shown	Capillary tube	01334085
Not shown	Inverter with hardware	01539725

Facade

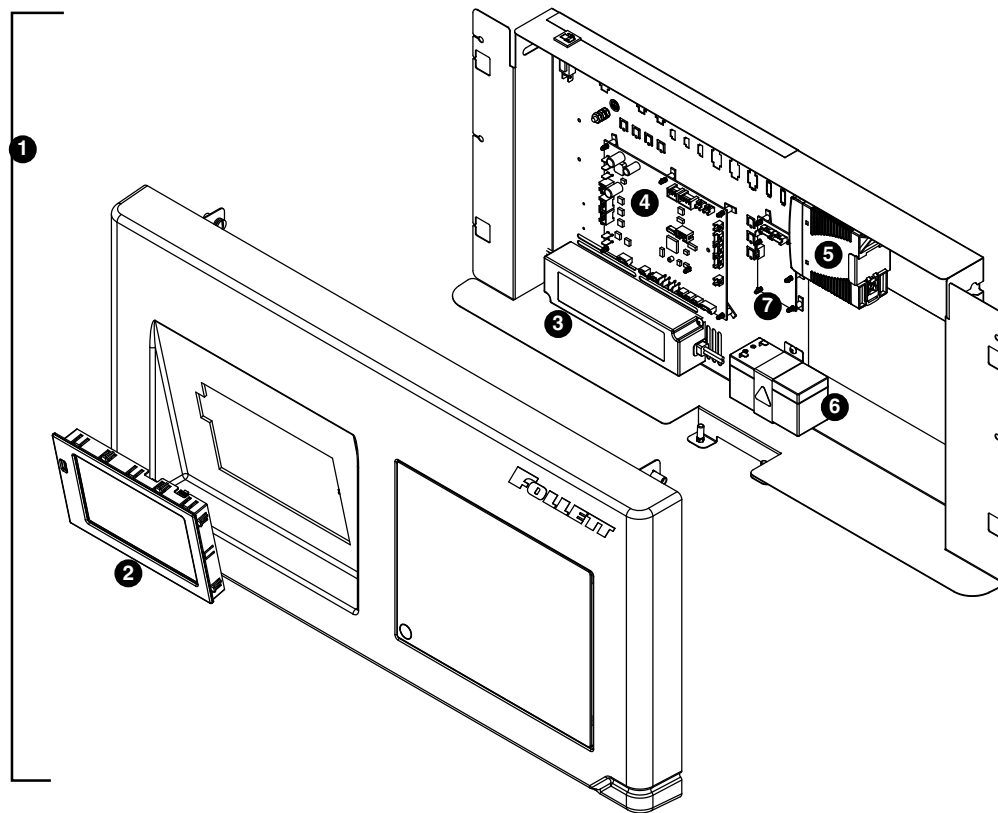

Reference	Description	Part #
1	Complete facade/control box assembly, without chart recorder	01552280
Not shown	Complete facade/control box assembly, with chart recorder	01552462
2	Infinity Series Touchscreen display	01552132
Not shown	Power switch	207360
3	Power supply (LEDs, condenser fan, evaporator fan), 100W, 24 Vdc output	01552215
4	Infinity Series control board	01552454
4	Infinity Series control board, with chart recorder	01552439
5	Battery charger, 12 Vdc	01552181
Not shown	Door switch/facade reed switch (does not include magnet)	01132091
Not shown	Harness, main ac power	01552207
Not shown	Cable, 3 wire, compressor communication signal, board-to-panel	01552173
Not shown	Cable, evaporator/condenser fan, board-to-panel	01552165
Not shown	Cable, LEDs, board-to-panel	01552157
Not shown	Cable, board to power switch	01552140
Not shown	Harness, chart recorder, Infinity Series	01552298
Not shown	Harness, board to touchscreen	01064856
Not shown	Harness, electronic lock, board-to-panel	01026848
Not shown	Chart recorder	00906198
Not shown	Chart recorder pens, box of 6	00918813
Not shown	Chart paper, degrees C (box of 50)	00918821
Not shown	Chart paper, degrees F (box of 50)	00967729
Not shown	Bayonet clip, male	00179549
Not shown	Bayonet clip receptacle, female	00179556
6	Battery, 12 V rechargeable	01552199

Reference	Description	Part #
7	RTD board (BB models only)	01143965
Not shown	Shell, upper side, REF25i	00940098
Not shown	Shell, upper side, REF20i	00925933
Not shown	Top ventilated cover	01519040
Not shown	Back support	00991695
Not shown	Harness, RTD probe, JST connectors, board-to-panel	01529098
Not shown	Harness, NTC probe, board-to-panel	01132075
Not shown	Latch fastener	00901165
Not shown	NIC card	01279686
Not shown	8A circuit breaker	00128090

Door assembly

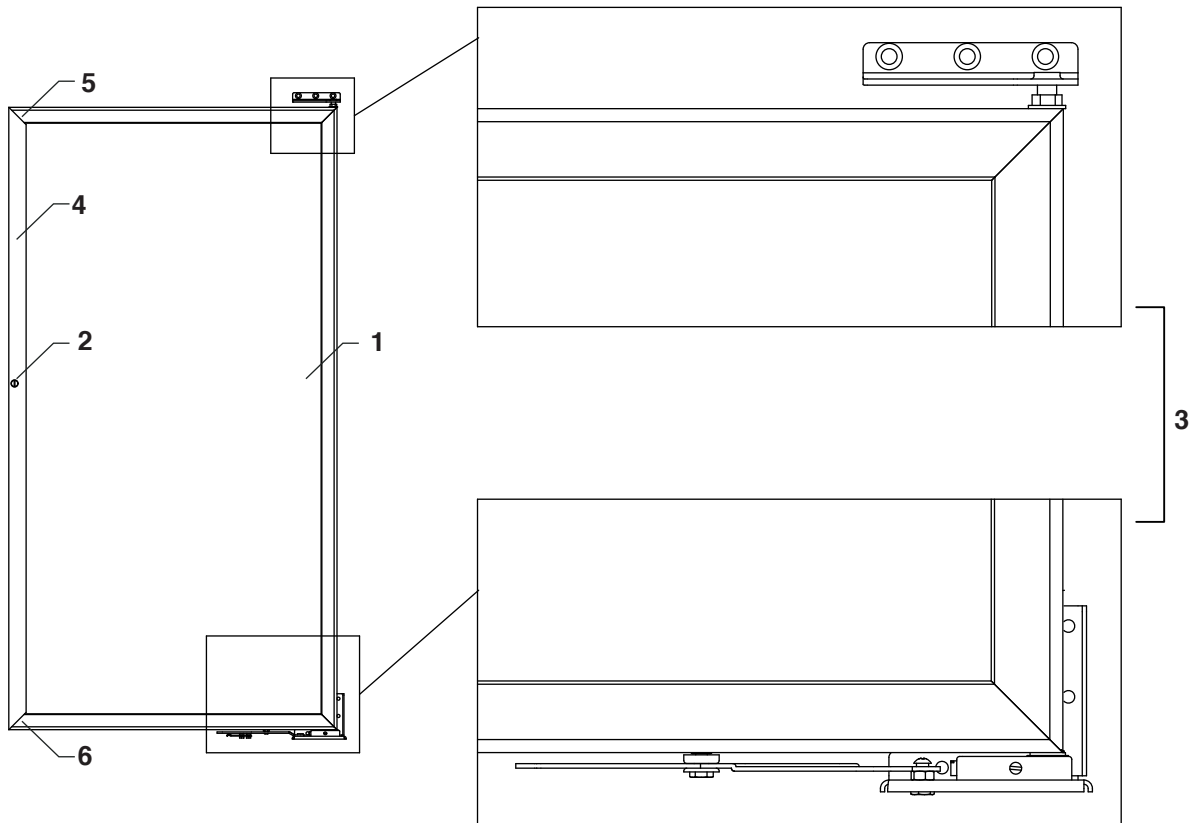

Reference	Description	Part #
Not shown	Door gasket, solid door	00960344
Not shown	Door gasket, glass door	00945345
Not shown	Glass door, non-heated, left-hand hinge	00939876
Not shown	Glass door, heated, left-hand hinge	00939991
Not shown	Solid door, left-hand hinge	00996611
Not shown	Glass door, non-heated, right-hand hinge	00939884
Not shown	Glass door, heated, right-hand hinge	00940007
1	Solid door, right-hand hinge	00996603
Not shown	Key, glass door	00945436
2	Lock, glass door	00945444
Not shown	Key, solid door	01035013
Not shown	Lock, solid door	00996629
Not shown	Lock bracket	00939983
Not shown	Door magnet kit (does not include facade reed switch)	00939967
3	Right-hand hinges with hardware	00996579
Not shown	Left-hand hinges with hardware	00996587
Not shown	Soft port kit	00940122
4	Solid door handle	00996637
5	Molded door handle cap, top	00989251
6	Molded door handle cap, bottom	00989244

Not shown	Seismic anchoring wall bracket	00927194
Not shown	Pyxis bracket kit	00927202
Not shown	Omnicell bracket kit	00966432
Not shown	Electronic lock	01065507
Not shown	Electronic lock bracket with screws	01278563
Not shown	Electronic lock door bracket	01151547
Not shown	Electronic lock cover	01289990
Not shown	KP ready solid door handle	01152065
Not shown	Solid door, KP ready, RH with hinges	01152149
Not shown	Solid door, KP ready, LH with hinges	01152131
Not shown	Glass door, KP ready, non-heated, RH with hinges	01152099
Not shown	Glass door, KP ready, non-heated, LH with hinges	01152081
Not shown	Glass door, KP ready, heated, RH with hinges	01152115
Not shown	Glass door, KP ready, heated, LH with hinges	01152107
Not shown	Adjuster, TorqueMaster	00984229

Cabinet

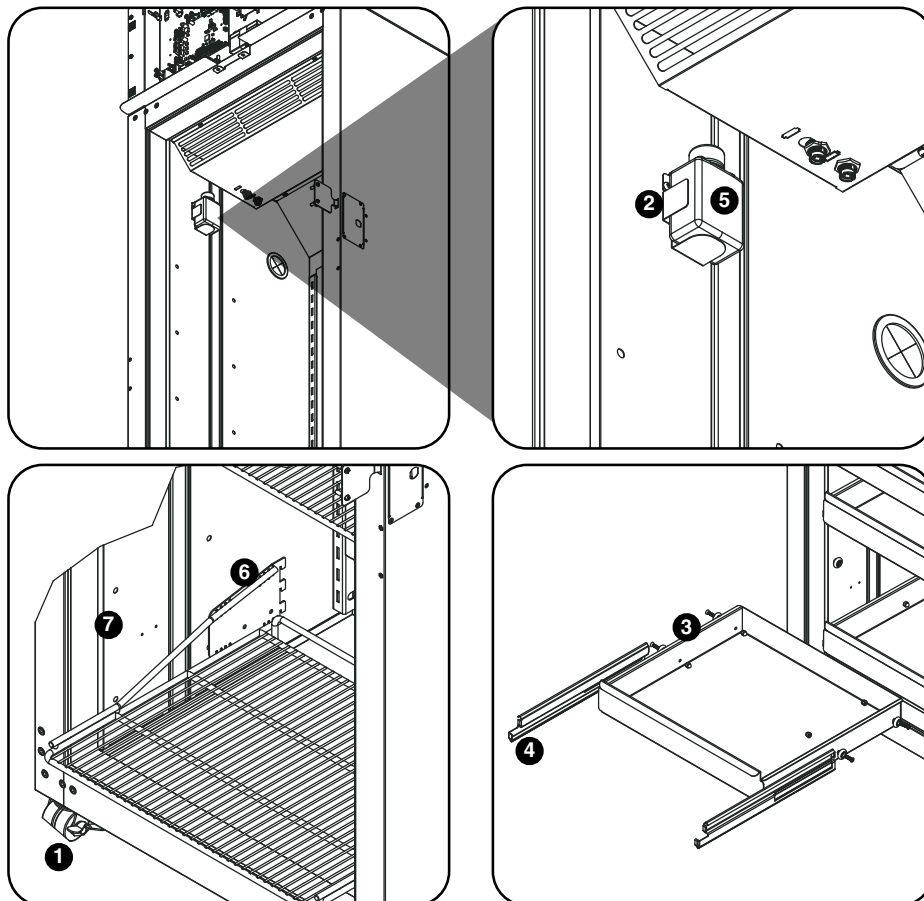

Reference	Description	Part #
1	Caster, swivel with brake	00187674
2	Bracket for 125 ml bottle (BB models only)	00171132
3	Drawer, assembly, REF25i	00939652
3	Drawer, assembly, REF20i	00939660
4	Slide, drawer, REF25i (set of 2)	00193045
4	Slide, drawer, REF20i (set of 2)	00188367
5	125 ml bottle with gasket (BB models only)	01015817
Not shown	Basket, assembly, REF25i	01548833
Not shown	Basket, assembly, REF20i	01548825
6	Shelf, REF25i	01548817
6	Shelf, REF20i	01548809
Not shown	Temperature probe, top/bottom, NIST calibrated	01540640
7	Cover, thermal break (4 pieces)	00922997
Not shown	LED, light strip	00980912
Not shown	Wire clip, probe	00919910
Not shown	Glycerine (1 pint)	00959296
Not shown	60 ml bottle with gasket and bracket	01053792

Warranty Registration and Equipment Evaluation

Thank you for purchasing Follett Products LLC equipment. We hope you find that our equipment meets or exceeds your expectations, as our goal is to deliver high value products and services that earn your complete satisfaction!

Please review the enclosed installation and operations manual. It is important that the installation be performed to factory specifications, so your equipment operates to its maximum efficiency.

Follett Products LLC will not be liable for any consequential damages, expenses, connecting or disconnecting charges or any losses resulting from a defect of the machine.

For full warranty details, visit our website www.follettice.com/productwarranties.

Warranty registration and equipment evaluation is important to help us keep track of our equipment and to record the machine's performance. We request that you register Follett equipment warranties on our website www.follettice.com/support and choose Warranty Registration and Equipment Evaluation. It's simple to do; please take a moment to register today. There is also space on the form to provide us with comments and feedback. Please let us know about your experience so we can capture it for our continuous improvement efforts.

We pride ourselves on producing outstanding equipment and we work hard to back it up with outstanding customer and technical support. Please let us know what else we can do to assist you. We would be happy to answer your questions.

FOLLETT and FOLLETT HEALTHCARE are registered trademarks of Follett Products, LLC, registered in the US.



801 Church Lane • Easton, PA 18040, USA
Toll free (877) 612-5086 • +1 (610) 252-7301
www.folletticehealthcare.com

01559038R06
© Follett Products, LLC 3/26